

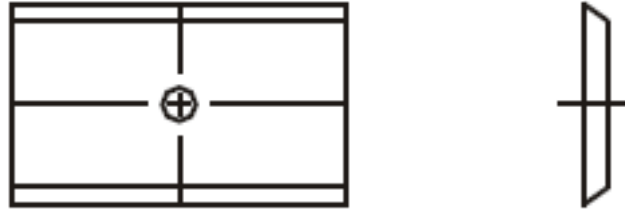

### Cemented Carbide Reversible Blade



Unit: mm

Type	L	W	T
CTC-T7.5×12×1.5	7.5	12	1.5
CTC-T8.6×12×1.5	8.6	12	1.5
CTC-T9×12×1.5	9	12	1.5
CTC-T9.6×12×1.5	9.6	12	1.5
CTC-T10×12×1.5	10	12	1.5
CTC-T11×12×1.5	11	12	1.5
CTC-T11.6×12×1.5	11.6	12	1.5
CTC-T15×12×1.5	15	12	1.5
CTC-T20×12×1.5	20	12	1.5
CTC-T25×12×1.5	25	12	1.5

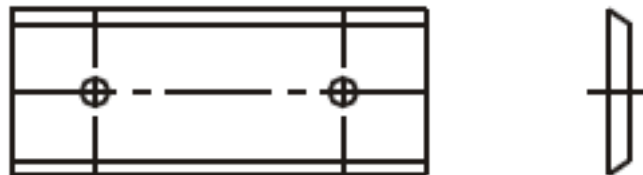

Unit: mm

Type	L	W	T	a
CTC-T25×12×1.5	25	12	1.5	14
CTC-T30×12×1.5	30	12	1.5	14
CTC-T40×12×1.5	40	12	1.5	26
CTC-T50×12×1.5	50	12	1.5	26
CTC-T60×12×1.5	60	12	1.5	26



Unit: mm

Type	L	W	T
CTC-T19.5×8×1.5	19.5	8	1.5
CTC-T19.5×9×1.5	19.5	9	1.5
CTC-T19.5×12×1.5	19.5	12	1.5



Unit: mm

Type	L	W	T	a
CTC-T29.5×8×1.5	29.5	8	1.5	14
CTC-T29.5×9×1.5	29.5	9	1.5	14
CTC-T29.5×12×1.5	29.5	12	1.5	14



Unit: mm

Type	L	W	T	a
CTC-T49.5×8×1.5	49.5	8	1.5	26
CTC-T49.5×9×1.5	49.5	9	1.5	26
CTC-T49.5×12×1.5	49.5	12	1.5	26
CTC-T60×12×1.5	60	12	1.5	



Unit: mm

Type	L	W	T
CTC-T50×12×1.7	50	12	1.7

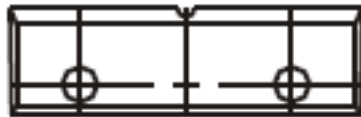

Unit: mm

Type	L	W	T
CTC-T16×7×1.5	16	7	1.5

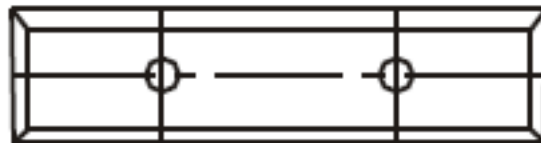

Unit: mm

Type	L	W	T	a
CTC-T16×7×1.5	16	7	1.5	7
CTC-T23×7×1.5	23	7	1.5	14
CTC-T28×7×1.5	28	7	1.5	14

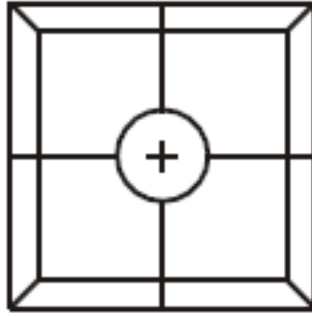

Unit: mm

Type	L	W	T	A	d
CTC-TLWT-I1	12	12	1.5	35°	4
CTC-TLWT-I2	17	17	2	35°	3
CTC-TLWT-I3	17	17	2	35°	4
CTC-TLWT-I4	13.6	13.6	2	30°	
CTC-TLWT-I5	13.6	13.6	2	45°	
CTC-TLWT-I6	14	14	1.2	30°	
CTC-TLWT-I7	14	14	1.7	22°	
CTC-TLWT-I8	14	14	1.7	30°	
CTC-TLWT-I9	14	14	2	30°	

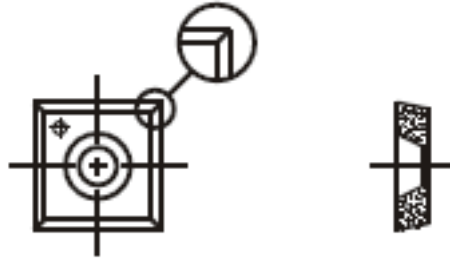

Unit: mm

Type	L	W	T	A
CTC-T14.3×14.3×2.5	14.3	14.3	2.5	35°
CTC-T14.6×14.6×2.5	14.6	14.6	2.5	30°
CTC-T15×15×2.5	15	15	2.5	30°

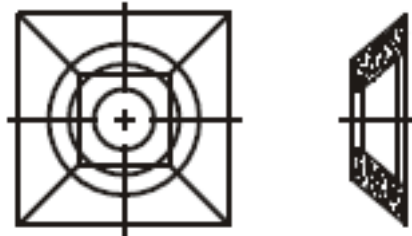

Unit: mm

Type	L	W	T	A
CTC-T21×21×5.5	21	21	5.5	40°

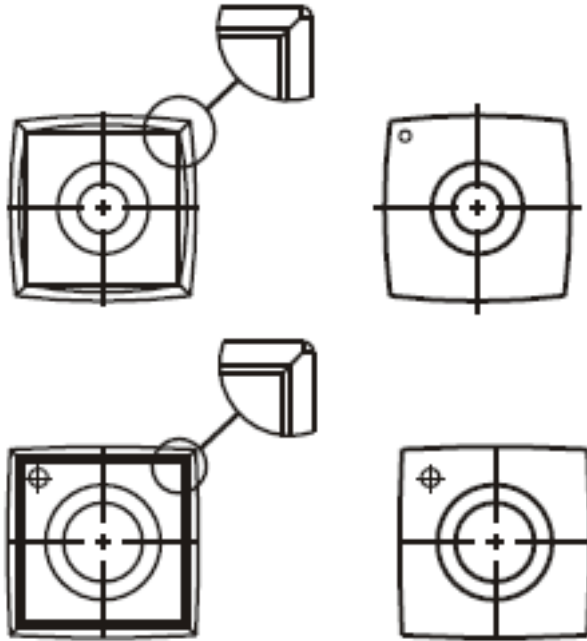

Unit: mm

Type	L	W	T	R
CTC-TLWT-L1	14	14	2	150
CTC-TLWT-L2	14.6	14.6	2.5	150
CTC-TLWT-L3	15	15	2.5	150
CTC-TLWT-L4	15	15	2.5	50
CTC-TLWT-L5	14	14	2	150
CTC-TLWT-L6	14.6	14.6	2.5	150
CTC-TLWT-L7	15	15	2.5	150
CTC-TLWT-L8	15	15	2.5	50

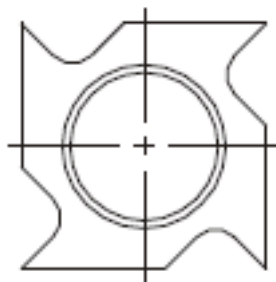

Unit: mm

Type	L	W	T
CTC-T18×18×1.95	18	18	1.95
CTC-T18×18×2.45	18	18	2.45
CTC-T18×18×2.95	18	18	2.95
CTC-T18×18×3.7	18	18	3.7



中钨在线(厦门)科技有限公司 CHINATUNGSTEN ONLINE (XIAMEN) MANU. & SALES CORP.  
厦门市软件园二期望海路 25 号 3楼 [www.chinatungsten.com](http://www.chinatungsten.com) [sales@chinatungsten.com](mailto:sales@chinatungsten.com)  
传真: 0592 512 9797 电话: 0592 512 9696/512 9595/ 13806045308



Unit: mm

Type	L	W	T	A
CTC-T22.9×19.8×2.5	22.9	19.8	2.5	30°
CTC-T22×19×2	22	19	2	30°
CTC-T22×22×2	22	22	2	